

Orthopedic medical products

Instructions for cleaning,
sterilization and maintenance



Copyright

© WITTENSTEIN intens GmbH 2021

This documentation is copyright protected.

WITTENSTEIN intens GmbH reserves all rights to photo-mechanical reproduction, copying, and the distribution by special processes (such as data processing, data carriers and data networks), in whole or in part.

Subject to technical and content changes without notice.

Date of issue of the instructions for cleaning, sterilization and maintenance: 12.04.2021

Contents

1 Purpose	2	5.7 Packaging	9
2 Instructions for processing according to standard	2	5.8 Sterilization	10
3 Warning information	2	5.9 Storage	10
4 Material resistance	4	5.10 Transport	11
5 Reprocessing instructions	4	6 Responsibilities of a hospital for hired sets	12
5.1 Pretreatment at the place of use	4	7 References	13
5.2 Preparation before cleaning	5	8 List of instruments with material numbers	14
5.3 Pre-cleaning	6	9 List of screws with material numbers	16
5.4 Automated cleaning and disinfection	6		
5.5 Drying	9		
5.6 Inspection and maintenance	9		

1 Purpose



The information on reprocessing is valid for all surgical instruments supplied by WITTENSTEIN intens GmbH, a list of which can be found in Chapter 8.











In addition, the information on the cleaning, disinfecting and sterilizing of the locking screws supplied by WITTENSTEIN intens GmbH described in Chapter 9 apply.

2 Instructions for processing according to standard

The process for cleaning, disinfecting and sterilizing in accordance with the standard EN ISO 17665-1/ISO 17665-1 [8] can be found below. The procedure has been validated in accordance with the standard EN ISO 17664/ISO 17665-1 [5] to guarantee its effectiveness. Alternative processing methods which are not included in this document may be suitable for treatment, but must be validated by the end user on a case-by-case basis. The instruments may only be treated by individuals with the necessary expertise and training. The end user must be able to assess the potential risks and the corresponding consequences.

3 Warning information

	<p>The lifespan of the instruments and the screws is limited by frequent reprocessing. There is a predefined maximum of 50 cleaning, disinfection and sterilization cycles unless material wear is present beforehand. After the lifespan has expired, responsibility lies with the end user.</p>
	<p>Due to their constant use, the instruments are subject to natural wear and tear and usage-specific damage which may influence the end of the product lifespan. In a non-exhaustive list, signs of damage and wear include: Corrosion (i.e. rust, pitting), discoloration, deep scratches, flaking, abrasions and cracks. Improperly functioning or defective and excessively worn instruments, as well as instruments with unrecognizable markings, missing or removed (worn away) part numbers may not be used and must be disposed of and replaced.</p>
	<p>Corrosion is a form of destruction or wear which can be caused as a result of chemical reactions, including:</p> <ul style="list-style-type: none"> – Damaged surface structures – The effects of human body fluids in the event of prolonged contact with the instruments – The excessive effects of certain solutions: Saline, iodine solutions, chloride or stronger acids, alkaline solutions and incorrectly used disinfectants – Insufficient water quality when cleaning, disinfecting, sterilizing using steam or rinsing instruments, e.g. through the use of corroded water pipes, the penetration of rust, metal or dirt particles in steam sterilizers etc. – If rust forms, this can be transferred onto other instruments. Ensure that contact is avoided, as this is very dangerous during sterilization! – Not observing the guidelines about concentrations and temperatures stipulated by the disinfectant manufacturer: If these concentrations and temperatures are significantly exceeded, for some materials this may lead to discoloration and/or corrosion. This can also be the case if the instruments are not rinsed sufficiently after cleaning or disinfection.

	<p>Equipment, users, cleaning agents and processes all contribute to the effectiveness of the treatment. The clinical institution must guarantee that the selected treatment stages are safe and effective.</p>		
	<p>During cleaning, you must carefully check which cleaning agent may be used and with which method. Please observe the diluting and application requirements.</p>		
	<p>Suitable protective equipment must be worn when dealing with contaminated or potentially contaminated materials, instruments and products.</p>		
	<p>The sterile containers and nop mats may <u>not</u> be used during the reprocessing process as they only serve to protect the instruments during transport.</p> <p>See sterile container label:</p> <table border="1" data-bbox="451 920 908 1081"> <tr> <td data-bbox="451 920 908 969">  WARNING </td> </tr> <tr> <td data-bbox="451 969 908 1081"> <p>Do not use sterile containers and silicone mats during the reprocessing process.</p> </td> </tr> </table>	 WARNING	<p>Do not use sterile containers and silicone mats during the reprocessing process.</p>
 WARNING			
<p>Do not use sterile containers and silicone mats during the reprocessing process.</p>			
	<p>In order to guarantee the transport of sterile instruments, the sterile container, the lid and the tray insert must be cleaned, disinfected and sterilized while empty.</p>		
	<p>Locking screws (implants) should not be cleaned and disinfected together with the instruments.</p>		
	<p>The maximum weight of a loaded tray insert during sterilization must be < 10 kg. [6]</p>		

Please inform the manufacturer WITTENSTEIN intens about any problems associated with the FITBONE® instruments by using the “FITBONE® incident report” form. [2]

4 Material resistance

When selecting the cleaning agent or disinfectant, you must ensure that they do not contain the following ingredients:

- Organic, mineral and oxidizing acids (minimum permissible pH value of 7)
- Strong alkaline solutions (maximum permissible pH value of 11)
- Organic solvents (e.g. alcohol, ether, ketone, gasoline)
- Oxidizing agents (e.g. hydrogen peroxide)
- Aromatic / halogenated hydrocarbons

Recommended cleaning agents: enzymatic, neutral or mildly alkaline cleaning agents

The instruments should not be cleaned using metal brushes or steel wool.

Recommended equipment: Nylon brushes, K-wire, lint-free disposable cloth and disposable sponge

All instruments may only be exposed to temperatures of up to 142 °C (286 °F).

Passivating agents which have been validated for this purpose are exceptions to this. Passivation must take place after cleaning and intermediate rinsing. (neodisher Z)

	Instruments made from anodized aluminum should not come into contact with certain disinfectant solutions or cleaning agents; which is why you should check the solution to be used for its application and compatibility with anodized aluminum before the metal is exposed to a chemical reaction.
---	--

	The validity of the specified parameters for cleaning, disinfection and sterilization in addition to the tolerance according to EN ISO 17665-1 [8] and ANSI AAMI ST79 [9]. Exceeding these parameters can shorten the service life of the instruments and is the responsibility of the hospital.
---	---

5 Reprocessing instructions

Reprocessing before using the instruments for the first time starts at Chapter 5.2 and at Chapter 5.1 for reprocessing instruments which were already in use.

5.1 Pretreatment at the place of use

During and/or immediately after operation, remove coarse contaminants (e.g. bodily fluids, bone meal and tissue) from the instruments.

- Contaminants can be wiped off using cloths;
- Rinse instruments with a lumen to avoid dried-on blood and bone meal in the inner lumen: Rinsing process with sterile distilled water [11] to clean the instruments (saline solution is not suitable);
- Return instruments to their assigned places after use;
- Do not place the instruments in the solution.

Make preparations to transport for reprocessing.

- To minimize the risk of substances drying on before cleaning and thus avoid irreparable damage, the instruments should be pre-cleaned and dried off within 30 minutes after use;
- Place the instruments in the correct trays and holders.

	All instruments which were used during the operation are deemed contaminated. The instruments are to be cleaned immediately after use.
---	---

Used instruments must be brought to be transported for cleaning in closed or covered containers to prevent any unnecessary risk of contamination and harm to personnel or the surrounding area.

5.2 Preparation before cleaning

Instruments with removable parts must be taken apart.

- Affected instruments:

- Material number (MN) 60000408 - Depth gauge for sleeves

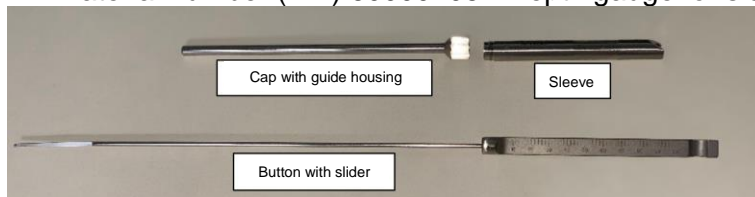

- Disassembly procedure:



Depth gauge for sleeves assembled



Unscrew cap with guide housing from button with slider



Remove cap with guide housing from button with slider on the left

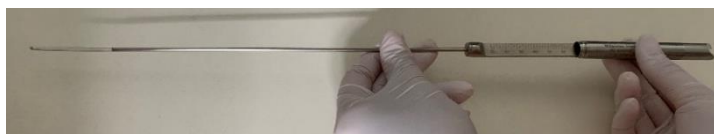

Remove sleeve to the right



Depth gauge for sleeves disassembled

- The responsible person must have been appropriately trained for disassembly or assembly.



In general, screws, nuts, studs and other small parts should be stored together and in a well-arranged way.

5.3 Pre-cleaning



Applies for all instruments listed in Chapter 8 “List of instruments“. It does not, however, apply to the locking screws.

To pre-clean the instruments thoroughly, they must be treated in an ultrasonic bath and then cleaned manually.

- Ultrasonic bath with neodisher MediZym 0.5% (v/v) and soft drinking-quality water [13]
- Before placing an instrument in the ultrasonic bath, any bodily fluids must be removed from the instruments using absorbent, lint-free paper towels;
- Avoid bubbles on the surface and sound shadows when placing them;
- When filling the ultrasonic bath, make sure that the instruments cannot hit each other;
- Ultrasonic treatment of the instruments (10 minutes, 35 kHz, water temperature <40°C)
- Rinse the instruments under running water [13]
- Make sure to remove all visible contaminants with
 - soft nylon brushes: Interlock cleaning brush – double sided, REF 09098 green
 - soft round nylon brushes: Interlock REF26035
- Inner diameter or holes must be cleaned with material-specific round brushes and rinsed well **at least three times for at least one minute** and rinse **at least five times** with at least one disposable 10ml syringe.



- **Afterwards, the instruments must always undergo automated cleaning and disinfection.**
- **The integrity of the instruments must be checked before they undergo cleaning and disinfection (see Chapter 5.4).**

5.4 Automated cleaning and disinfection

It is recommended that cleaning is carried out with a correctly installed, qualified and regularly maintained **washing and disinfection machine (Miele PG 8535)** which has been validated in accordance with EN ISO 15883-1/ISO 15883-1 [4].

- In the event of deviations from the process detailed here, equivalent cleaning agents and a procedure validated by the end user must be used. Otherwise, this may shorten the lifespan of the instruments and locking screws, and this would be the responsibility of the hospital.
- The operating instructions supplied by the manufacturer of the cleaning machines and cleaning agents must be observed;

The instruments are, in accordance with the operating instructions, inserted into the washing and disinfection machine using a cleaning trolley (Miele E 450/1 69545003D).

- Clean instruments which can be taken apart when disassembled.
 - o Depth gauge for sleeves (MN 60000408);

- Cannulae must be connected to the rinse connections (injector nozzle Miele A 834 69745403D) of the washing and disinfection machine.

Instruments with cannulae



- Load trays in accordance with *Overview of instrument inventory (6091-D001701) [1]* and lay instruments on the bottom of the tray:

Instruments without cannulae

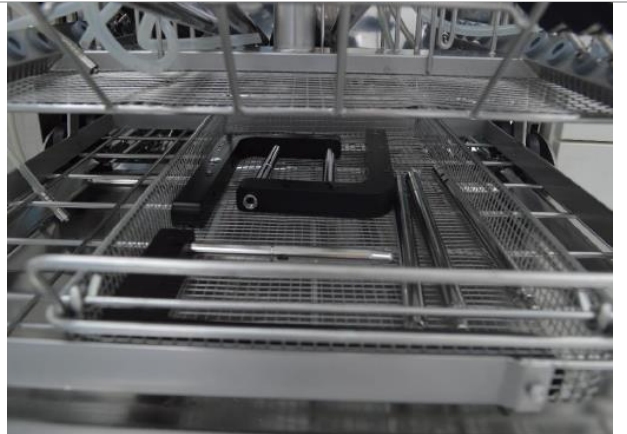

- MN 60000398 Spiral drill D4.5 L300
- MN 60000403 Trocar D4.5
- MN 60000405 Trocar D4.5, T-handle
- MN 60000384 Screw holder M2 L325
- MN 60000576 Screwdriver SW3.5
- MN 60000317 Tapping tool
- MN 60000688 Test pin D4.5
- MN 60000689 Open-end wrench SW14/17
- MN 60000408 Depth gauge – button with slider
- MN 60001184 Mounting bracket TAA
- MN 60001175 Drill guide TAA
- MN 60000175 Retaining screw M6 L9
- MN 60000003 Locking screw
- MN 60000219 Clamping nut TAA
- MN 60001439 Spot-film device 45°/90°
- MN 60001307 Wire trap 90°
- MN 60001415 Step reamer TAA1160
- MN 60001179 Step reamer TAA1180
- MN 60000832 Dummy TAA1160-T-225
- MN 60000822 Dummy TAA1180-F-245
- MN 60000513 Retaining screw M4 L400

- MN 60000410 Pliers for screws
- MN 60001039 K-wire D3 L28
- MN 60001139 Dummy TAA1160-F-225
- MN 60001185 Drill guide blocking screw TAA11
- MN 60001244 Dummy TAA1140-T-205
- MN 60001248 Dummy TAA1140-F-205
- MN 60001464 GRID plate
- MN 60001495 Dummy TAA1180-T-245
- MN 60001528 Step reamer TAA1140
- MN 60001605 Spiral drill D4.5 L300, conical
- MN 60001623 Dummy TAA1380-F-245
- MN 60001854 Dummy TAA0960-F-220
- MN 60001855 Dummy TAA0960-T-220
- MN 60001925 Dummy TAA0940-F-200
- MN 60001927 Dummy TAA0940-T-200
- MN 60001848 Spiral drill D4.0 L200
- MN 60001849 Step reamer TAA0960
- MN 60001938 Step reamer TAA0940
- Screws in the screw box

- Avoid contact between the instruments during the washing process;
- Remove wash items immediately after the end of the wash program to avoid corrosion created by residual moisture.

The process validated by WITTENSTEIN intens is intended for the following cleaning and disinfection methods:

Cleaning and disinfection device: PG 8535, Miele

Cleaning program:

	Solution	Temperature	Duration
Pre-rinsing	Soft, drinking-quality water [13]	< 10 °C	2 minutes
Cleaning	Neodisher MediClean forte 0.7% (v/v); (*)	55 °C	10 minutes
Rinsing I	De-mineralized water [6]	< 10 °C	1 minute
Neutralizing (*)	Neodisher Z 0.1% (v/v)	< 10 °C	2 minutes
Rinsing II	De-mineralized water [6]	< 10 °C	1 minute
Thermal Disinfection	-	93 °C	5 minutes or until achieving an A ₀ value of > 3000.
Drying	-	100 °C	for 25 minutes

(*) Only necessary for strong alkaline cleaners, however these must also have a pH value of < 12

After the program is complete, the machine must be unloaded and the medical products checked (see 5.6). If the products still show contamination residues, they must undergo another cleaning process in the machine.

	<ul style="list-style-type: none"> - Due to structural, material and functional properties, these are medical products of the critical risk class A & B according to RKI recommendations [12], which is why they may only be treated by the machine. - The integrity of the instruments must be checked after the cleaning program (see 5.6).
---	---

5.5 Drying

Every instrument and every locking screw must be completely dry on the inside and outside to prevent the formation of rust or malfunctions.

If the instruments are not dry following the drying step in the thermal disinfection process, dry the instruments. Lint-free cloths may be used.

5.6 Inspection and maintenance

Before every sterilization or use, all parts of the instrument inventory and all the locking screws must be checked for cleanliness, integrity and proper functioning.

- During the visual inspection, under good light with a magnifying class, if applicable, all instruments must be examined for contamination, corrosion and residues;
- If the visual inspection shows that the instruments have not been cleaned properly, they must be cleaned and disinfected again.
- Damaged parts may not be used and must be re-ordered for replacement from WITTENSTEIN intens.

5.7 Packaging

Disassembled instruments must be re-assembled by trained personnel.

- Affected instruments:

- MN 60000408 - Depth gauge for sleeves

Disassembly procedure: see Chapter 5.2, reverse procedure

After the inspection and functional test, the dried instruments are placed in the tray and the locking screws are placed in the screw box. The tray is then double packed with fleece. For packing, use the AAMI double-fleece or an equivalent method. [9]

The fleece / wrapping cloth used must conform to the requirements of EN ISO 11607-1/ISO 11607-1. [10]

In the USA, an FDA cleared sterilization wrap must be used and conforming with ANSI/AAMI ST79 is mandatory.

- Inner fleece: "Parallel" packaging technique
- Sheet packaging, blue fleece, 52g, 120 x 120 cm (EU: stericlin, item no.: 3FVLI330118)
- Adhesive tape, beige, 19 mm / 50 m, with STEAM indicator (EU: stericlin, item no.: 3FKLB410102)

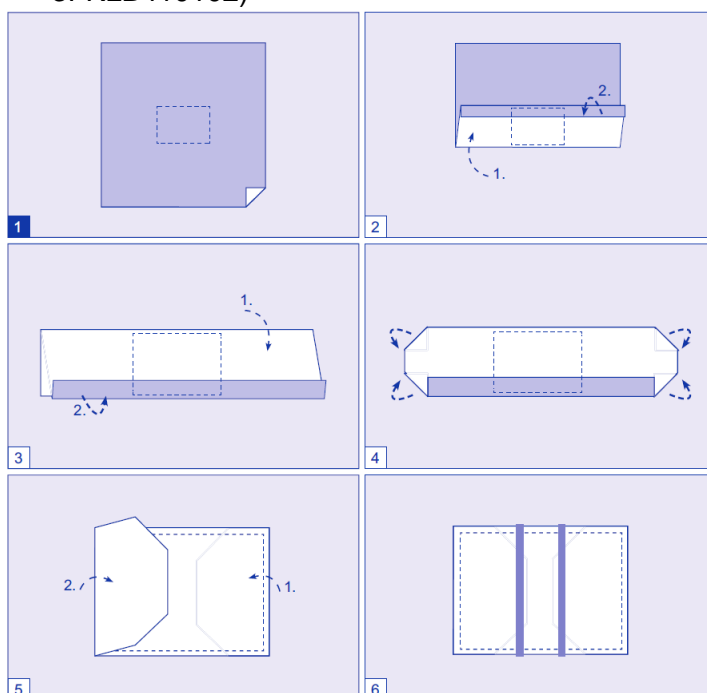

Figure 1: "Parallel" packaging technique [14]

- Outer fleece: "Diagonal" packaging technique
- Sheet packaging, blue fleece, 52g, 120 x 120 cm (EU: stericlín, item no.: 3FVLI330118)
- Adhesive tape, beige, 19 mm / 50 m, with STEAM indicator (EU: stericlín, item no.: 3FKLB410102)

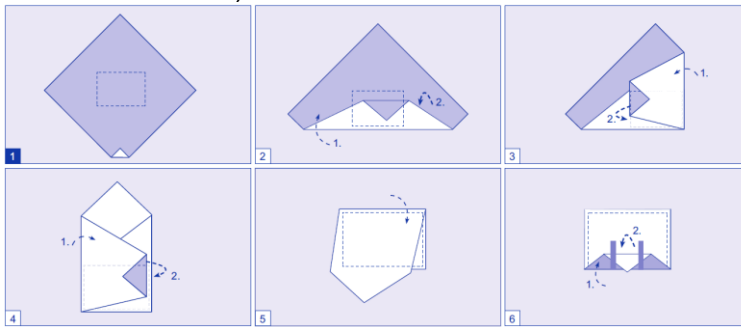



Figure 2: "Diagonal" packaging technique [14]

	Instruments with points may damage the sterile barrier system.
---	---

5.8 Sterilization

The instruments must be sterilized in steam autoclaves (moist heat) with a pre-vacuum cycle (forced de-aeration).

- The autoclaves used must meet the requirements of *EN 285* [6], *EN 13060* [7], *EN ISO 17665-1/ISO 17665-1* [8] and *ANSI/AAMI ST79* [9] and be validated and maintained accordingly with regard to compliance with these standards.

	The sterilization container and nop mats may <u>not</u> be used during sterilization.
---	--

The following minimum parameters were validated by WITTENSTEIN intens for sterilization in accordance with *EN ISO 17665-1/ISO 17665-1* [8], and have a SAL value of 10^{-6} :

Large steam sterilizer: Lautenschläger ZentraCERT 3100 LAB

Sterilization parameters (steam sterilization):

	Outside the USA	In the USA
Acting temperature	134 °C (273.2 °F)	132 °C (269.6 °F)
Acting time	5 minutes	4 minutes
Drying time	20 minutes at 120 °C (248 °F)	20 minutes at 120 °C (248 °F)

5.9 Storage

After sterilization, the packed medical products should be stored in a location with restricted access.

- This location should be well ventilated and offer sufficient protection from dust, moisture, insects, vermin and extreme temperatures.



- Before the products can be stored, they must be cooled after sterilization.
- Before opening, sterile packaged medical products must be thoroughly examined for any damage to their packaging and the expiry date must be checked.

5.10 Transport

A container shall be used for transport within a hospital. For this purpose, the tray with the instruments and screw box with the locking screws shall be packaged in AAMI double fleece, placed in the container and sealed with the lid.



Please handle the container with care in order to maintain the sterile barrier system. The container contains sterile instruments with points.

6 Responsibilities of a hospital for hired sets

Orthopedic surgical instruments generally have a long lifespan. This has been demonstrated by our instruments and locking screws being reprocessed 50 times. However, incorrect handling or insufficient protection can quickly shorten this service life. These instruments or locking screws which no longer work properly due to a long period of use, incorrect handling or improper maintenance should be disposed of.

Before returning hired sets to WITTENSTEIN intens, they should be decontaminated, cleaned, disinfected, inspected and then sterilized. Along with the returned instruments, you should also present WITTENSTEIN intens with *Cleaning and sterilization evidence* (6097-D003374) [3].

If instruments or locking screws from hired sets are missing or damaged, please inform the manufacturer or the distributor. This is the only way to establish that a complete and functioning set of instruments with locking screws will be available for the next operation.

The instructions contained in this handbook were validated by WITTENSTEIN intens in the laboratory and are suitable for use.

It is the responsibility of the hospital to ensure that 1. the treatment is carried out with suitable equipment and materials and 2. the employees tasked with these activities have been trained accordingly. This is also the only way to achieve the desired results.

The equipment, as well as the processes, should be validated and monitored routinely.

To prevent any potential unwanted consequences, all deviations in processing should be properly evaluated for their effectiveness by the employees.

7 References

- [1] 6091-D001701: Overview of instrument inventory
- [2] 6097-D000761 FITBONE® incident report en/de
- [3] 6097-D003374: Cleaning and sterilization evidence of instruments and instrument sets
- [4] EN ISO 15883-1:2009-06+A1:2014-07/ISO 15883-1:2006-04+AMD1:2014-07: Washer disinfectors - Part 1: General requirements, terms and definitions and tests (Reinigungs-Desinfektionsgeräte - Teil 1: Allgemeine Anforderungen, Begriffe und Prüfverfahren)
- [5] EN ISO 17664:2017-12/ISO 17664:2017-10: Processing of health care products - Information to be provided by the medical device manufacturer for the processing of medical devices (Sterilisation von Medizinprodukten - Vom Hersteller bereitzustellende Informationen für die Aufbereitung von reesterilisierbaren Medizinprodukten)
- [6] EN 285:2015-12: Sterilization - Steam sterilizers - Large sterilizers (Sterilisation - Dampf-Sterilisatoren - Groß-Sterilisatoren)
- [7] EN 13060:2018-11: Small steam sterilizers (Dampf-Klein-Sterilisatoren)
- [8] EN ISO 17665-1:2006-08/ISO 17665-1:2006-08: Sterilization of health care products – Moist heat – Part 1: Requirements for the development, validation and routine control of a sterilization process for medical devices (Sterilisation von Produkten für die Gesundheitsfürsorge - Feuchte Hitze)
- [9] ANSI/AAMI ST79:2010+A1:2010+A2:2011+A3:2012+A4:2013: Comprehensive guide to steam sterilization and sterility assurance in health care facilities
- [10] EN ISO 11607-1:2017-07/ISO 11607-1:2019-02: Packaging for terminally sterilized medical devices -- Part 1: Requirements for materials, sterile barrier systems and packaging systems (Verpackungen für in der Endverpackung zu sterilisierende Medizinprodukte — Teil 1: Anforderungen an Materialien, Sterilbarrieresysteme und Verpackungssysteme)
- [11] Ph. Eur., European Pharmacopoeia, 2017
- [12] RKI directive: Hygiene requirements for the reprocessing of medical devices, Anforderungen an die Hygiene bei der Aufbereitung von Medizinprodukten (Empfehlung der Kommission für Krankenhaushygiene und Infektionsprävention (KRINKO) beim Robert Koch-Institut (RKI) und des Bundesinstitutes für Arzneimittel und Medizinprodukte (BfArM)), 2012
- [13] TrinkwV: Drinking water ordinance – regulation on the quality of water for human use, 05-2001
- [14] 2012-05-00; Directions for use – wrapping material, stericlin

8 List of instruments with material numbers

MN 60000392	T-handle
MN 60000398	Spiral drill D4.5 L300
MN 60000400	Drill sleeve D4.5 black
MN 60000402	Drill sleeve D8.0 green
MN 60000403	Trocar D4.5
MN 60000405	Trocar D4.5, T-handle
MN 60000384	Screw holder M2 L325
MN 60000406	Screwdriver SW3.5, cannulated
MN 60000576	Screwdriver SW3.5
MN 60000317	Tapping tool
MN 60000688	Test pin D4.5
MN 60000689	Open-end wrench SW14/17
MN 60000408	Depth gauge
MN 60000411	Reamer D8.0 L200 L480, rounded
MN 60000412	Reamer D9.0 L100 L480, front-cutting
MN 60000413	Reamer D9.0 L200 L480, rounded
MN 60000414	Reamer D10.0 L100 L480, front-cutting
MN 60000415	Reamer D10.0 L200 L480, rounded
MN 60000416	Reamer D10.5 L200 L480, rounded
MN 60000417	Reamer D11.0 L100 L480, front-cutting
MN 60000418	Reamer D11.0 L200 L480, rounded
MN 60000833	Reamer D11.5 L200 L480, rounded
MN 60000419	Reamer D12.0 L100 L480, front-cutting
MN 60000420	Reamer D12.0 L200 L480, rounded
MN 60000716	Reamer D12.5 L200 L480, rounded
MN 60000421	Reamer D13.0 L100 L480, front-cutting
MN 60000422	Reamer D13.0 L200 L480, rounded
MN 60000423	Reamer D13.5 L200 L480, rounded
MN 60000834	Reamer D8.0 L200 L700, rounded
MN 60000835	Reamer D9.0 L100 L700, front-cutting
MN 60000836	Reamer D9.0 L200 L700, rounded
MN 60000837	Reamer D10.0 L100 L700, front-cutting
MN 60000838	Reamer D10.0 L200 L700, rounded
MN 60000839	Reamer D10.5 L200 L700, rounded
MN 60000840	Reamer D11.0 L100 L700, front-cutting
MN 60000841	Reamer D11.0 L200 L700, rounded
MN 60000842	Reamer D11.5 L200 L700, rounded
MN 60000843	Reamer D12.0 L100 L700, front-cutting
MN 60000844	Reamer D12.0 L200 L700, rounded
MN 60000845	Reamer D12.5 L200 L700, rounded
MN 60000846	Reamer D13.0 L100 L700, front-cutting
MN 60000847	Reamer D13.0 L200 L700, rounded
MN 60000848	Reamer D13.5 L200 L700, rounded
MN 60001184	Mounting bracket TAA
MN 60001175	Drill guide TAA
MN 60000175	Retaining screw M6 L9
MN 60000003	Locking screw
MN 60000218	Spacer TAA
MN 60000219	Clamping nut TAA
MN 60000310	Connection screw TAA
MN 60001439	Spot-film device 45°/90°
MN 60001307	Wire trap 90°
MN 60001415	Step reamer TAA1160
MN 60001179	Step reamer TAA1180
MN 60000832	Dummy TAA1160-T-225
MN 60000822	Dummy TAA1180-F-245
MN 60000425	Reamer D14.0 L200 L480, rounded

MN 6000426	Reamer D15.0 L200 L480, rounded
MN 6000513	Retaining screw M4 L400
MN 6000410	Pliers for screws
MN 60001014	Tube T14/13-M
MN 60001015	Tube T13/12-M
MN 60001016	Tube T12/11-M
MN 60001017	Tube T12/10-M
MN 60001018	Tube T12/09-M
MN 60001019	Tube T12/08-M
MN 60001020	Tube T12/11-L
MN 60001021	Tube T12/10-L
MN 60001022	Tube T12/09-L
MN 60001023	Tube T12/08-L
MN 60001024	Tube T12/11-XL
MN 60001025	Tube T12/10-XL
MN 60001026	Tube T12/09-XL
MN 60001027	Tube T12/08-XL
MN 60001028	Cone C13
MN 60001029	Cone C13+
MN 60001030	Cone C13++
MN 60001031	Cone C12
MN 60001032	Cone C11
MN 60001033	Tube sinker TS13
MN 60001034	Tube sinker TS12
MN 60001035	Tube sinker TS11
MN 60001036	Cone sinker CS15-13
MN 60001037	Cone sinker CS12-11
MN 60001038	Clamp
MN 60001039	K-wire D3 L280
MN 60001044	Tube T14/13-S
MN 60001045	Tube T13/12-S
MN 60001046	Tube T12/11-S
MN 60001047	Tube T12/10-S
MN 60001048	Tube T12/09-S
MN 60001049	Tube T12/08-S
MN 60001050	Tube T16/15-M
MN 60001051	Tube T15/14-M
MN 60001052	Tube T16/15-L
MN 60001053	Tube T15/14-L
MN 60001054	Tube T14/13-L
MN 60001055	Tube T13/12-L
MN 60001056	Tube T16/15-XL
MN 60001057	Tube T15/14-XL
MN 60001058	Tube T14/13-XL
MN 60001059	Tube T13/12-XL
MN 60001060	Cone C15
MN 60001061	Cone C15+
MN 60001062	Cone C15++
MN 60001063	Cone C14
MN 60001064	Tube sinker TS15
MN 60001065	Tube sinker TS14
MN 60000849	Reamer D14.0 L200 L700, rounded
MN 60000850	Reamer D15.0 L200 L700, rounded
MN 60001139	Dummy TAA1160-F-225
MN 60001185	Drill guide blocking screw TAA11
MN 60001244	Dummy TAA1140-T-205
MN 60001248	Dummy TAA1140-F-205

MN 60001464	GRID plate
MN 60001495	Dummy TAA1180-T-245
MN 60001528	Step reamer TAA1140
MN 60001605	Spiral drill D4.5 L300, conical
MN 60001623	Dummy TAA1380-F-245
MN 60001636	Impact sleeve
MN 60001888	Cone C13 retropatellar
MN 60001854	Dummy TAA0960-F-220
MN 60001855	Dummy TAA0960-T-220
MN 60001925	Dummy TAA0940-F-200
MN 60001927	Dummy TAA0940-T-200
MN 60001848	Spiral drill D4.0 L305
MN 60001849	Step reamer TAA0960
MN 60001938	Step reamer TAA0940

9 List of screws with material numbers

MN 60000572	Locking screw D4.5 L80, long
MN 60000571	Locking screw D4.5 L75, long
MN 60000570	Locking screw D4.5 L70, long
MN 60000569	Locking screw D4.5 L65, long
MN 60000568	Locking screw D4.5 L60, long
MN 60000567	Locking screw D4.5 L55, long
MN 60000369	Locking screw D4.5 L50, long
MN 60000368	Locking screw D4.5 L45, long
MN 60000367	Locking screw D4.5 L40, long
MN 60000366	Locking screw D4.5 L35, long
MN 60000365	Locking screw D4.5 L30, long
MN 60000364	Locking screw D4.5 L25, long
MN 60000363	Locking screw D4.5 L20, long
MN 60000272	Locking screw D5.8 L80
MN 60000271	Locking screw D5.8 L75
MN 60000270	Locking screw D5.8 L70
MN 60000269	Locking screw D5.8 L65
MN 60000268	Locking screw D5.8 L60
MN 60000267	Locking screw D5.8 L55
MN 60000266	Locking screw D5.8 L50
MN 60000265	Locking screw D5.8 L45
MN 60000264	Locking screw D5.8 L40
MN 60000263	Locking screw D5.8 L35
MN 60000262	Locking screw D5.8 L30
MN 60000260	Locking screw D4.5 L50, short
MN 60000259	Locking screw D4.5 L45, short
MN 60000258	Locking screw D4.5 L40, short
MN 60000257	Locking screw D4.5 L35, short
MN 60000256	Locking screw D4.5 L30, short
MN 60000255	Locking screw D4.5 L25, short
MN 60000254	Locking screw D4.5 L20, short
MN 60000503	Hollow screw 3.5x40mm VG
MN 60001828	Locking screw D4.0 L20, short
MN 60001829	Locking screw D4.0 L25, short
MN 60001830	Locking screw D4.0 L30, short
MN 60001831	Locking screw D4.0 L35, short

In case of technical queries, please contact the manufacturer:

WITTENSTEIN intens GmbH
Walter-Wittenstein-Straße 1
97999 Igersheim
Germany

Tel.: +49 7931 493-0
Fax: +49 7931 493-10906
Email: info-intens@wittenstein.de





WITTENSTEIN intens GmbH · Walter-Wittenstein-Straße 1 · 97999 Igersheim · Germany
Tel. +49 7931 493-0 · info@wittenstein-intens.com

WITTENSTEIN – one with the future

www.wittenstein-intens.com