

SKYHAWK[®]

LATERAL INTERBODY FUSION SYSTEM

LATERAL PLATE SYSTEM

TABLE OF CONTENTS

Introduction	1
Pre-Operative Technique	2
Operative Technique	3
Part Numbers	14
Indications for Use	16

The surgical technique shown is for illustrative purposes only. The technique(s) actually employed in each case will always depend upon the medical judgment of the surgeon exercised before and during surgery as to the best mode of treatment for each patient. Please see Instructions for Use for the complete list of indications, warnings, precautions, and other important medical information.

INTRODUCTION

Lateral Lumbar Interbody Fusion is an approach to spinal fusion in which the surgeon accesses the intervertebral disc space using a surgical approach from the patient's side (lateral) rather than from the front (anterior) or the back (posterior). The lateral approach provides an alternate route to the spine that disturbs fewer structures and tissues. Lateral Lumbar Interbody Fusion is an option that a surgeon may use to treat patients with lumbar degenerative disc disease (DDD).

The SKYHAWK Lateral Interbody Fusion System and SKYHAWK Lateral Plate System provide a complete solution for the surgeon to perform a Lateral Lumbar Interbody Fusion.

SKYHAWK interbody spacers are composed of PEEK and tantalum and are available in heights ranging from 8mm to 14mm, widths of 18mm and 22mm, lengths of 40mm to 55mm and lordosis of 0° and 8°.

SKYHAWK lateral plates and bone screws are manufactured from titanium alloy; plates are available in sizes 6mm, 8mm, 10mm, 12mm and 14mm and bone screws are available in 5.5mm and 6.5mm diameters and lengths of 30mm to 60mm.

A complete listing of indications for use, contraindications, precautions and warnings for the SKYHAWK Lateral Interbody Fusion System and the SKYHAWK Lateral Plate System is located at the back of this Operative Technique as well as within the associated Instructions For Use leaflets.

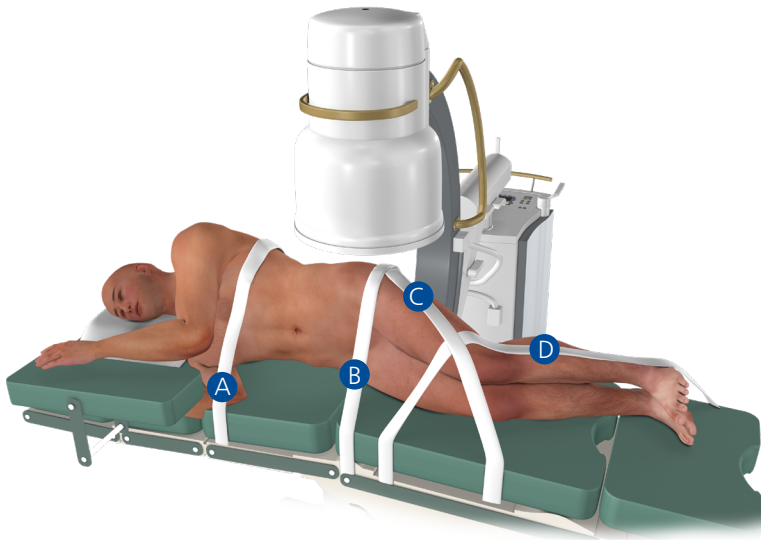

Fig. 1

1. PATIENT POSITIONING

Carefully place the patient in a direct lateral decubitus position on the operating table with the iliac crest just above the table break (**Fig. 1**). Ensure the patient is secured to the table with tape in the following regions:

- a) Over the thoracic region
- b) Just below the iliac crest
- c) From the iliac crest to the knee
- d) From the table to the knee – past the ankle

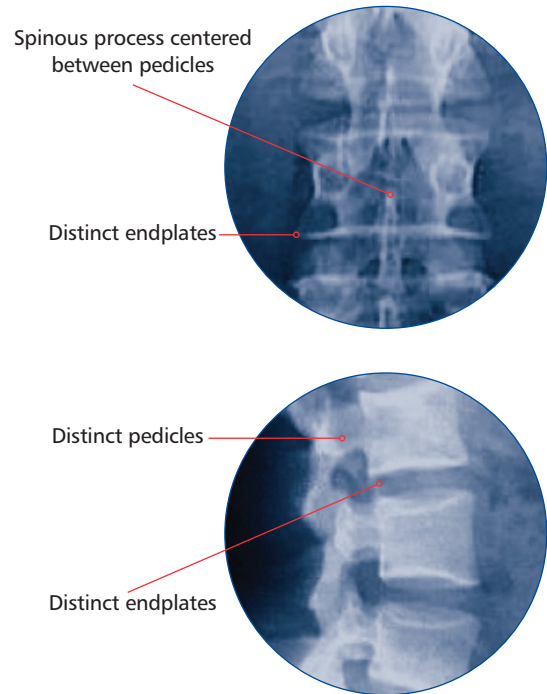

Fig. 2

2. PRE-OPERATIVE FLUOROSCOPY

Under fluoroscopy guidance, flex the operating table to increase the distance between the iliac crest and the ribs to improve access to the disc. Keeping the C-Arm at 0°, adjust the table so that the C-Arm provides a true AP and true lateral when at 90° (**Fig. 2**).

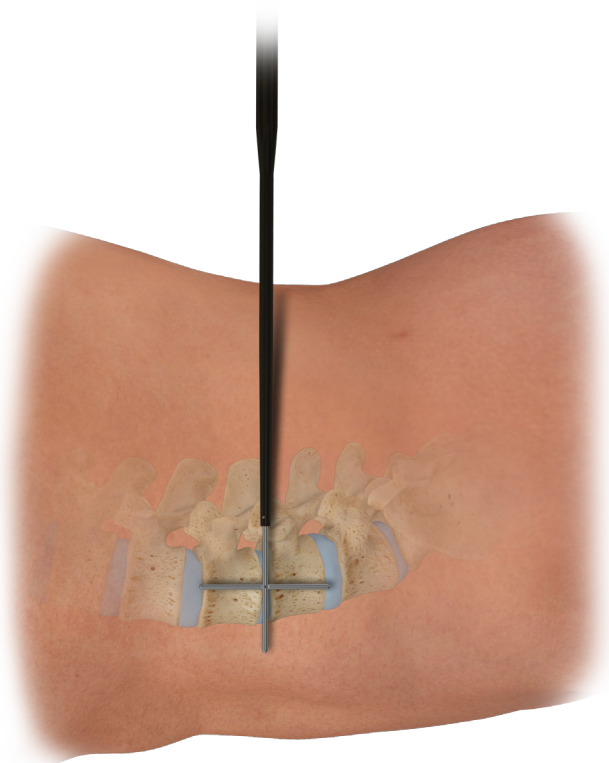

Fig. 3a

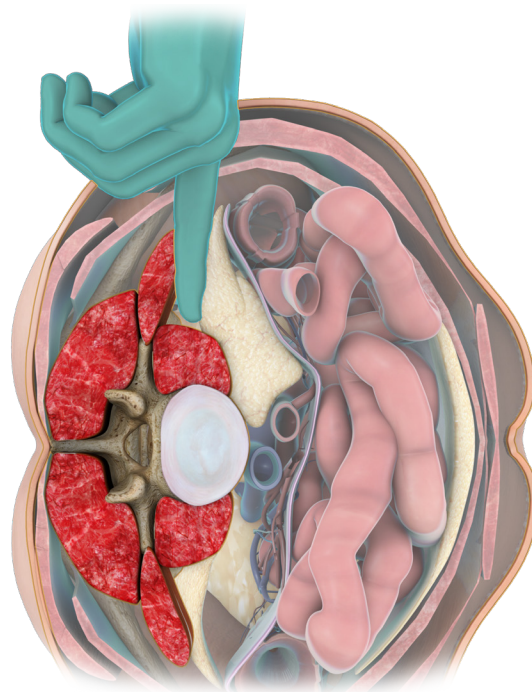

Fig. 3b

3. INCISION AND RETROPERITONEAL ACCESS

Using fluoroscopy and the **Fluoroscopic Targeting Crosshair (71-5010) (Fig. 3a)** localize the disc and mark the intended incision on the skin. Through a sufficient incision, open the muscle fascia and split the muscle layers to enter the retroperitoneal space by using a blunt instrument or finger dissection. Avoid abrupt advancement which could cause perforation of the peritoneum.

Once inside the retroperitoneal space

- Use the index finger to sweep the peritoneum anteriorly (**Fig. 3b**)
- Palpate the Psoas muscle and tip of the transverse process

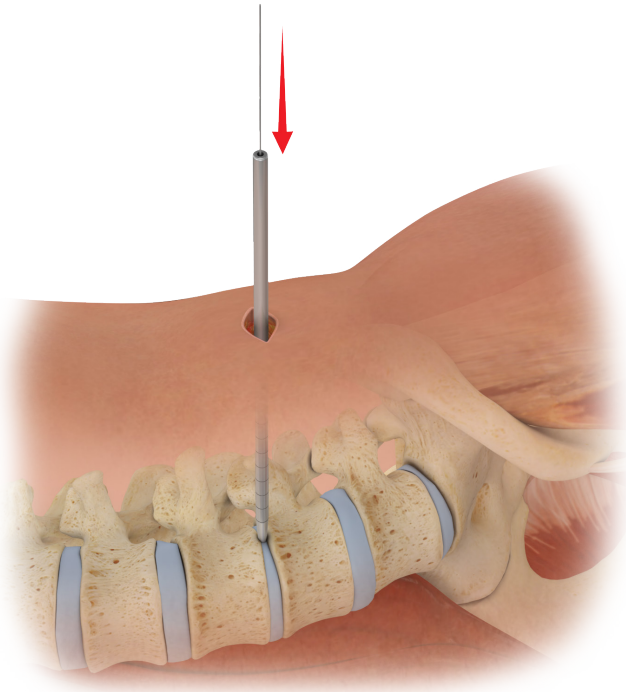

Fig. 4a

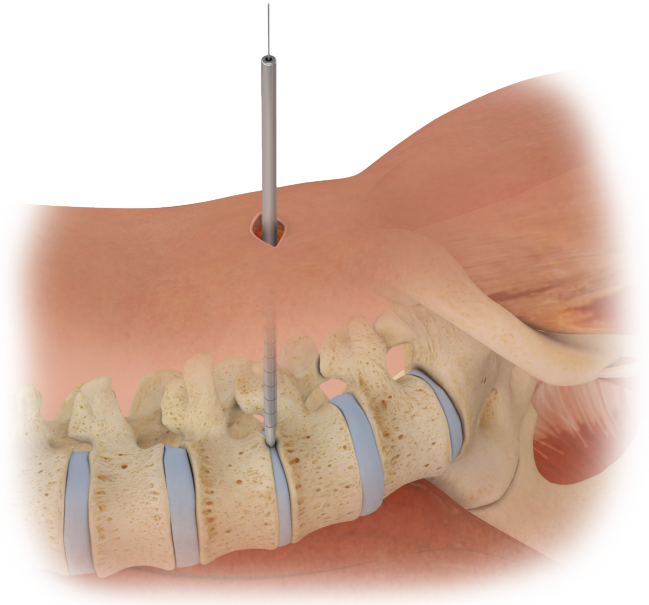

Fig. 4b

4. LATERAL APPROACH AND ACCESS

After the peritoneum is swept anteriorly, introduce a Dilator. A finger may be placed into the incision to ensure the peritoneum is out of the way of the Dilator. Upon reaching the top of the psoas muscle, ensure with lateral fluoroscopy that the Dilator is just posterior to the center of the disc space. The **Dilator Holder (71-5040)** may be used to aid imaging. Guide the Dilator through the psoas muscle and onto the disc (**Fig. 4a**). Once the Dilator is through the psoas and on the disc, pass a **Guide Wire (71-5015)** through the cannula of the Dilator. Note the numerical depth markings on the Dilator closest to the skin as this will serve as a guide for selecting the Retractor Blade length in **section 5**.

Remove the Dilator while leaving the Guide Wire in place (**Fig. 4b**).

Note: Neuromonitoring should be considered during advancement of the dilator. A disposable neuromonitoring pack is available (**7332-99**).

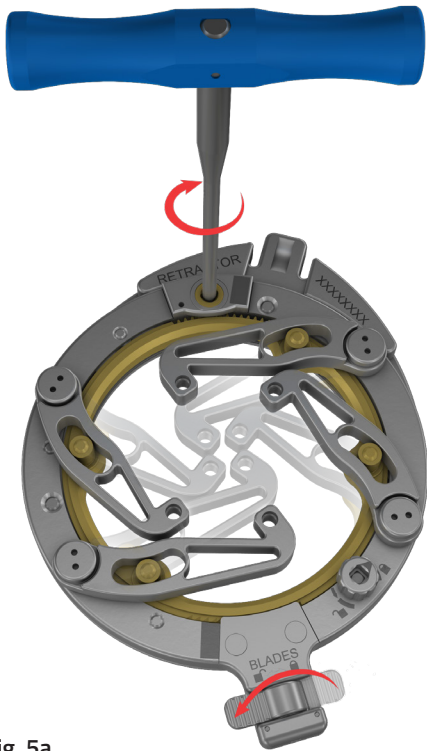

Fig. 5a

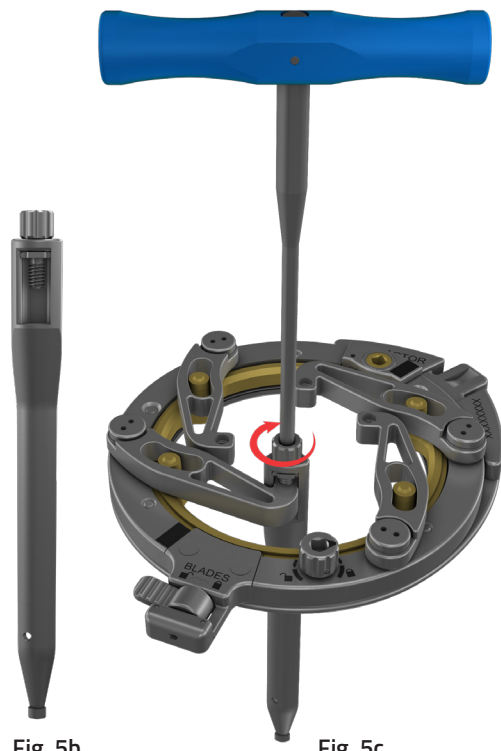

Fig. 5b

Fig. 5c

5. RETRACTOR PLACEMENT

With the **QUADRx™ Retractor (71-1000)** in an unlocked position, fully seat the **Retractor Driver (71-1500)** into the gold knob and turn it clockwise (**Fig. 5a**) to open its four arms in order to insert the **Blades (71-11XX)**.

Fasten a **Blade (Fig. 5b)** to each Retractor arm by inserting the end of the arm into the Blade's pocket. (**Fig. 5c**) Securely tighten the Blade onto the arm using the Retractor Driver.

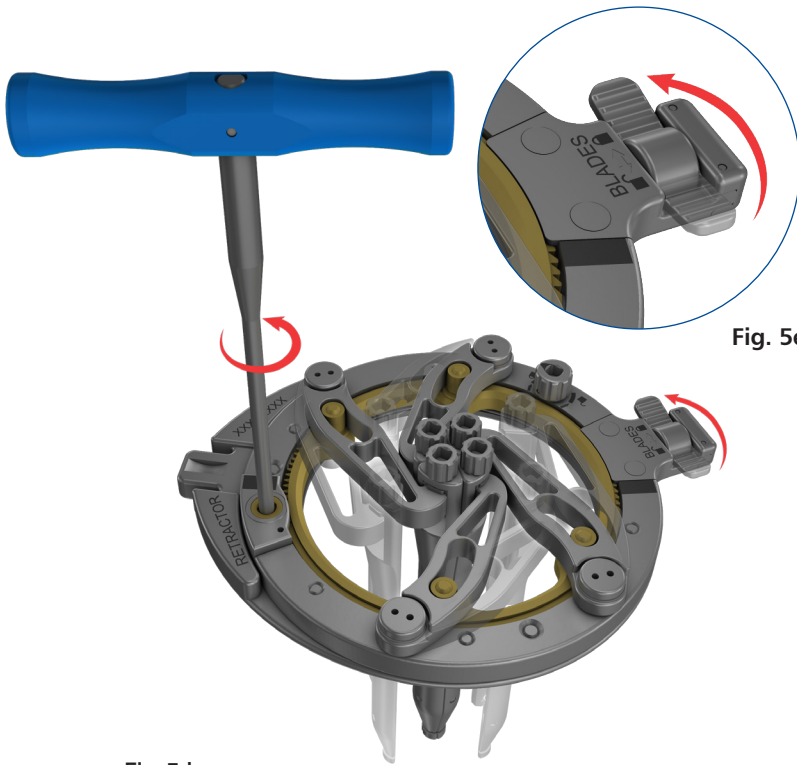

Fig. 5d

5. RETRACTOR (cont.)

Once all four Blades are attached, turn the gold knob counterclockwise with the Retractor Driver to fully collapse the Retractor (**Fig. 5d**). Flip the locking lever on the Retractor to lock the Blades (**Fig. 5e**).

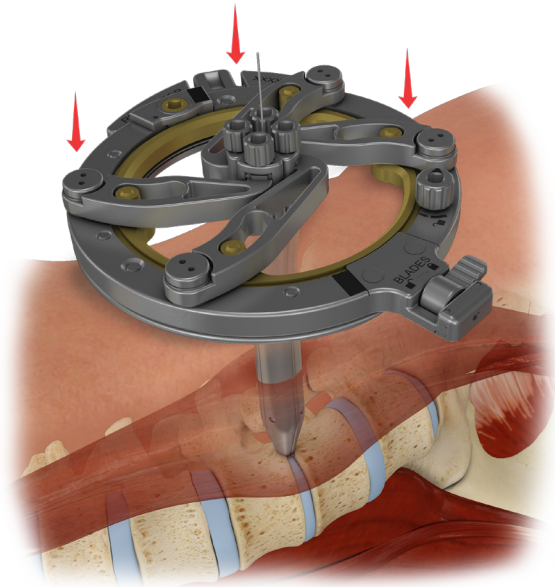

Fig. 5f

Insert the Retractor with the Blades installed and collected over the guide wire into the incision (**Fig. 5f**). Confirm with fluoroscopy that the Retractor Blades have reached and are in line with the disc space. Remove Guide Wire.

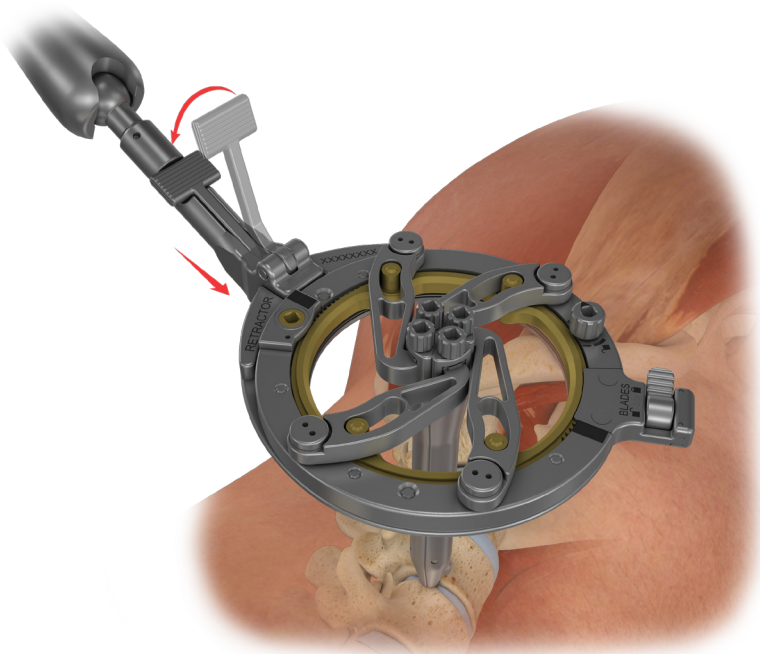

Fig. 5g

Attach the **Table Arm (71-2000)** to the Retractor frame with its lever in the open position. Press the lever down to lock the Table Arm to the retractor (**Fig. 5g**). Firmly tighten the large knob on the Table Arm to stabilize the assembly once the desired position over the patient has been achieved.

The Retractor provides a rectangular aperture when expanded. Unlock the grooved knob on the frame with the Retractor Driver. Once unlocked, the Retractor frame will rotate freely. To correctly orient the Retractor, align the black rectangular bands parallel to the disc space to maximize the opening. Once positioned, use the Retractor Driver to turn the grooved knob to the lock position following the laser marking as a guide.

Note: Ensure secure locking of the Retractor frame to avoid unexpected movement of the Blades while tissue is being retracted.

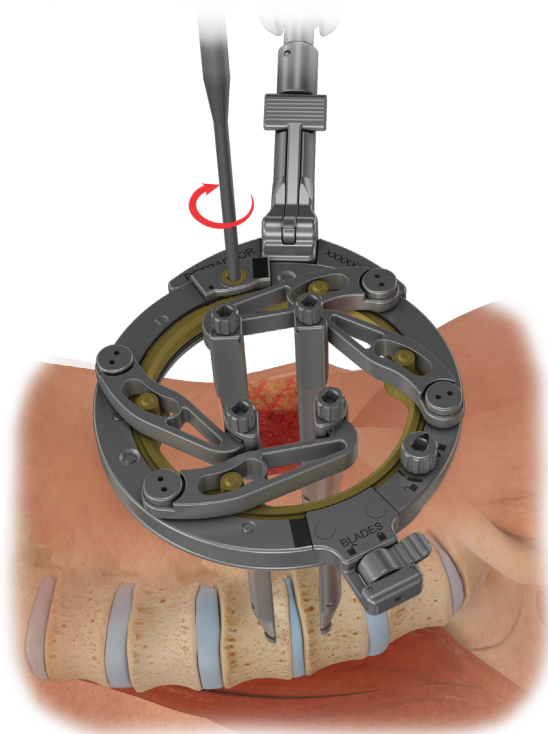

Fig. 5h

With the lever in the locked position, expand the Retractor Blades by fully seating the Retractor Driver into the gold knob and turning clockwise (**Fig. 5h**). The Blades will ratchet open. Make sure the distal tips of the Blades are clear of any bony structures and carefully expand the Retractor only as far as necessary to expose the disc space.

Note: Neuromonitoring should be considered during expansion of the Retractor.

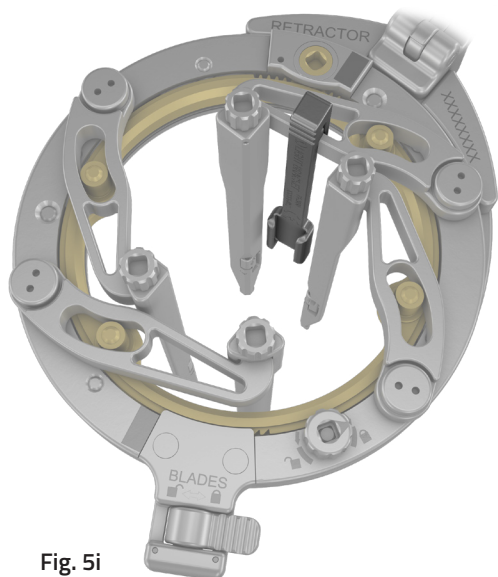

Fig. 5i



Fig. 5j

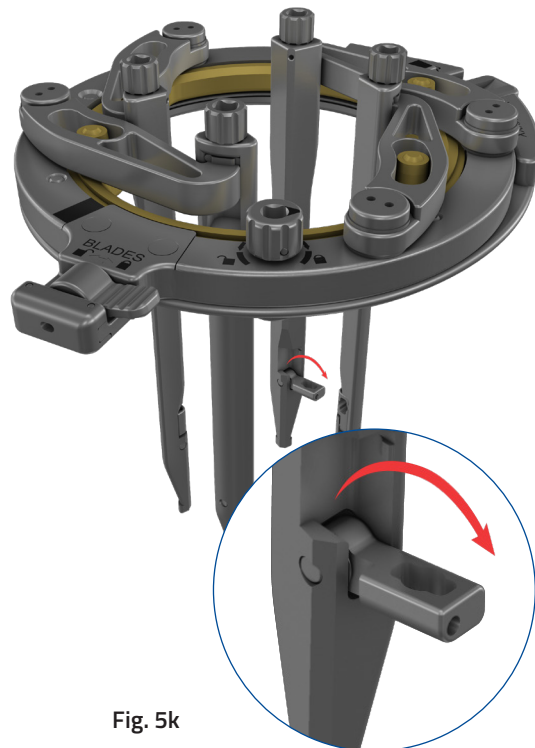

Fig. 5k

5. RETRACTOR (cont.)

If additional lighting is required, once the Retractor is open, snap the **Light Bracket (71-2030)** on any arm of the Retractor (**Fig. 5i**).

Note: The Retractor should be opened at least to the fourth click to ease installation of the Light Bracket.

Note: A disposable Fiberoptic Light Source (**71-3040**) is available for use with the light bracket.

For added stability, the **Intradiscal Shim (71-4100)** or **Bone Pin (71-4200)** may be used as needed (**Fig. 5j**). Using the **Shim Inserter (71-4300)**, pull back the inserter sleeve and rotate the sleeve into the locked position. Align the hex of the Intradiscal Shim or Bone Pin into the distal tip on the Shim Inserter until seated securely. Rotate the Shim Inserter sleeve out of the locked position. The sleeve is spring loaded and should cover the distal tip of the inserter. Insert the Intradiscal Shim or Bone Pin through the kickstand located on the interior wall of the Retractor Blades (**Fig. 5k**). Slide back the Shim Inserter sleeve once the Intradiscal Shim and Bone Pin are positioned and remove the Shim Inserter from the incision. The **Nerve Root Retractor (26-1025)** may be utilized to gently manipulate exposed nerves or tissue out of the way to prepare the disc for visualization.

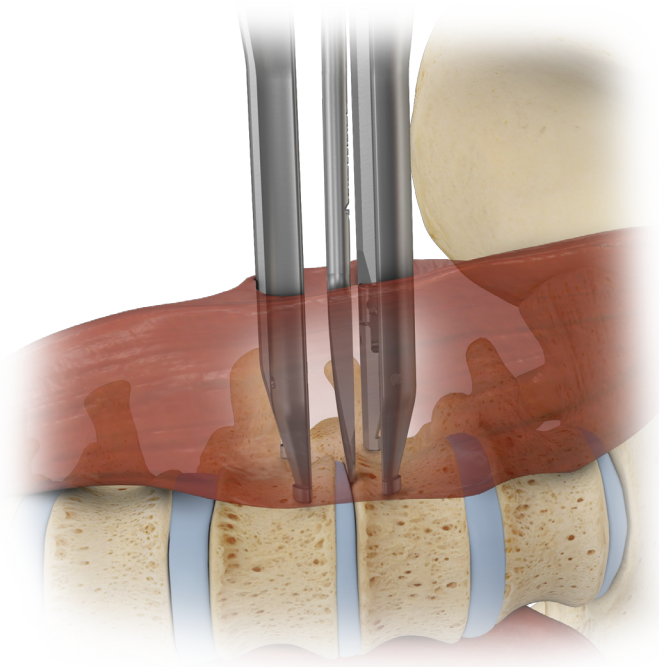

Fig. 6

6. ANNULOTOMY AND DISC SPACE PREPARATION

Create a circumferential incision in the disc with a blade attached to the **Annulotomy Blade Holder (26-1030)**. Take the **Cobb Elevator (26-102X)** and advance it completely along the endplates to release the contralateral annulus (**Fig. 6**). Take care not to disrupt the anterior longitudinal ligament or posterior longitudinal ligament (ALL or PLL). Pituitaries, Curettes, Disc Cutters, Rasps, and other disc preparation instruments can be used with fluoroscopy to evacuate the disc and prepare the endplates.

When using the **Box Chisels (26-13XX)**, be sure to align the box portion with the disc space with the aid of fluoroscopy.

Caution: The **Modular T-handle (27-5004)** should not be used for setting the orientation of the Box Chisel end.

Note: The **Modular In-Line Handle (24-1001)** and **Modular T-Handle (27-5004)** utilize a spring loaded collar. Always ensure the handles are fully engaged prior to use by pulling on the selected instrument.



Fig. 7a

Fig. 7b

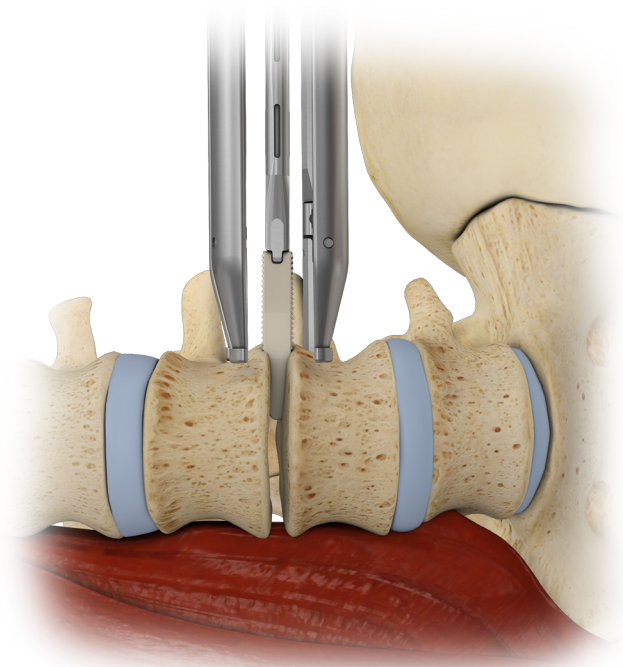

Fig. 7c

7. INTERBODY SPACER SIZING AND PLACEMENT

Fasten the selected **Trial (27-5XXX)** onto the **Implant Inserter (27-5010)** until fully seated (**Fig. 7a**). Under AP fluoroscopy, gently impact the Trial into the disc space. The Trials have markings that aid in determining the appropriate Interbody length. Once the implant size has been established, remove the Trial from the disc space. Securely fasten the corresponding **Interbody (27-1XXX, 27-2XXX, 27-3XXX, 27-4XXX)** on the Implant Inserter until fully seated (**Fig. 7b**). Place autograft in the window of the Interbody. To help retain the autograft during insertion attach the **Graft Containment Clip (27-56XX)** above the Interbody and slide over.

Note: The lines on the trial indicate the length of the implant needed. The first line indicates a 45mm length and each subsequent line is spaced 5mm apart to represent all lengths available between 45mm and 60mm. The entire trial from distal to proximal indicates a 60mm length implant.

Gently impact the Interbody into the disc space under guidance of fluoroscopy. (**Fig. 7c**) The depth and orientation of the Interbody can be assessed by visualizing the tantalum markers through fluoroscopy. If repositioning is needed, use the **Tamp (27-5012)** to adjust the Interbody position. Once the Interbody is positioned, remove any Intradiscal Shims or Bone Pins and raise the kickstands. Slightly collapse the Retractor Blades and remove the light bracket. The Skyhawk Lateral Interbody Fusion System is intended to be used with supplemental internal spinal fixation.

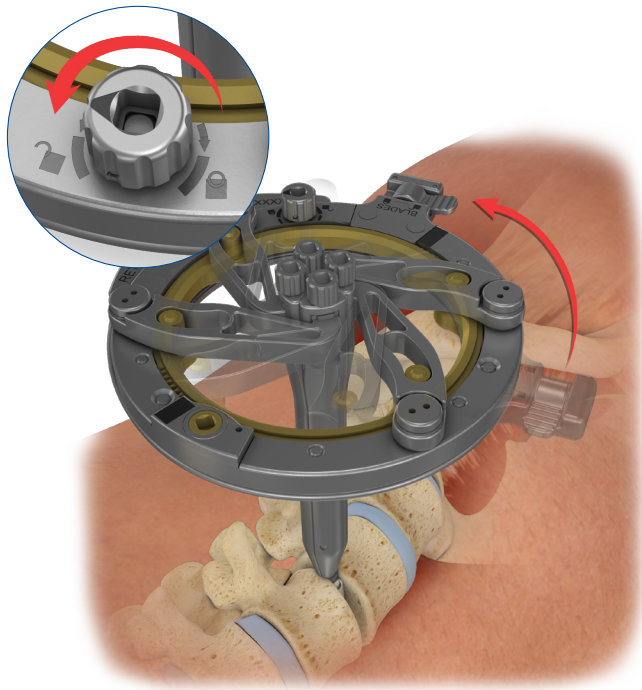

Fig. 8a

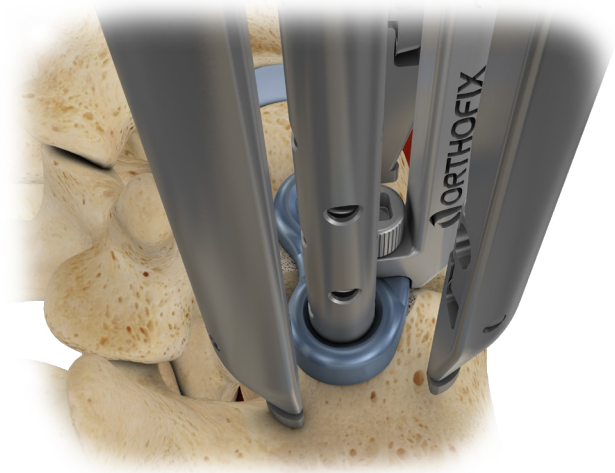

Fig. 8b

8. LATERAL PLATE PLACEMENT AND FIXATION

Unlock the Retractor frame using the Retractor Driver and turn the grooved silver knob to an unlocked position (**Fig. 8a**). Rotate the Retractor until the black laser-marked lines are in the cephalad/caudal plane. Lock the Retractor in place. Expand the Retractor as instructed previously in **step 5**.

Prepare the lateral surface of the vertebral bodies removing lateral osteophytes with a **Bone Biting Rongeur (24-1050)**.

Thread the appropriate size **Plate (24-20XX)** that corresponds with selected Interbody height securely on the **Plate Inserter (24-1070)**. Pass the Plate down through the Retractor, and then confirm its positioning with fluoroscopy. In preparation for **Bone Screw (24-5XXX)** placement, use an Awl to make a pilot hole. When using the **Sleeved Awl (24-1060)**, ensure the sleeve is seated into the screw hole on the plate (**Fig. 8b**). Laser markings are available to measure penetration of the Sleeved Awl tip during impaction.

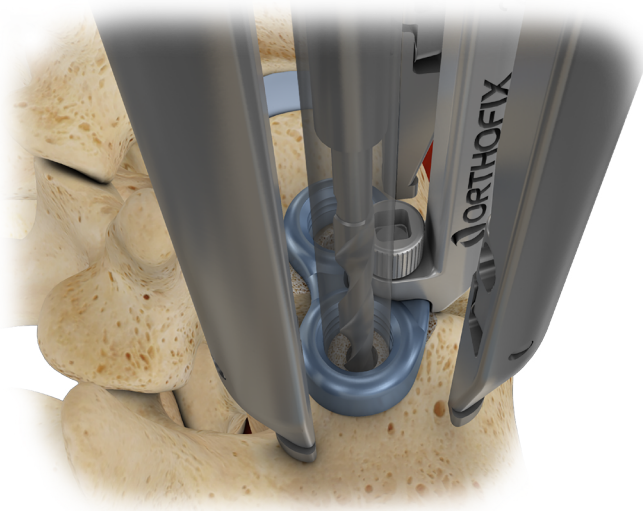

Fig. 8c

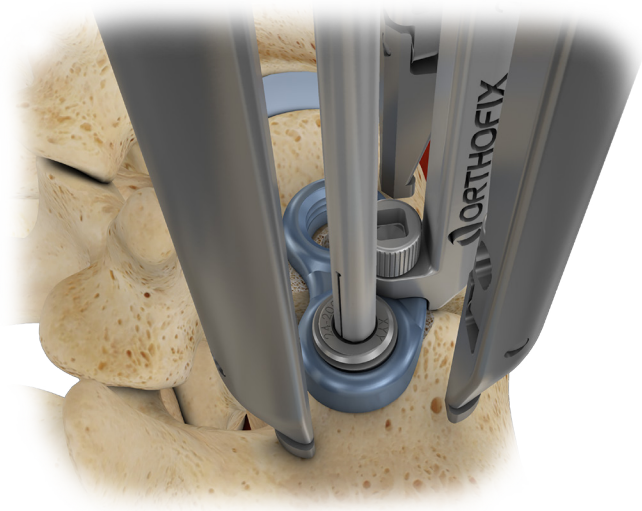

Fig. 8d

8. LATERAL PLATE (cont.)

When using the monolithic **Awl (24-1062)**, place the **Awl Sleeve (24-1061)** on the screw hole prior to introducing the Awl. A **Drill (24-1065)** is available to create the trajectory for the Bone Screws if preferable. (**Fig. 8c**).

Note: Be sure to use the Sleeve as a positive depth stop and seat the Sleeve into the screw hole on the plate when using both the Awl and Drill. Depth measurements can be taken from the Awl Sleeve while drilling.

Select the **Modular In-Line Handle (24-1001)** to use with the **Driver (24-1094)**. Bone Screws are fully seated on the Driver and inserted into the prepared holes. Advance the Bone Screws into the bone until seated in the Plate. Using the same Driver, thread two **Set Screws (24-2001)** into the plate (**Fig. 8d**). Take care to fully seat driver in the set screw before advancing it to prevent stripping. When introducing the Set Screw into the Plate, a half turn in the counter clock-wise direction before advancing in the clock-wise orientation will help reduce cross threading. Fully seat the solid tip **Final Tightening Driver (24-1092)** into the **Torque Limiting Driver (T-handle) (24-1095)**. The Torque Limiting Driver (T-handle) has a “click-out” torque limiting mechanism which provides audible and tactile confirmation to ensure the Set Screw is fully tightened.

Caution: To avoid stripping the Bone Screw holes do not over tighten Bone Screw into the Plate.

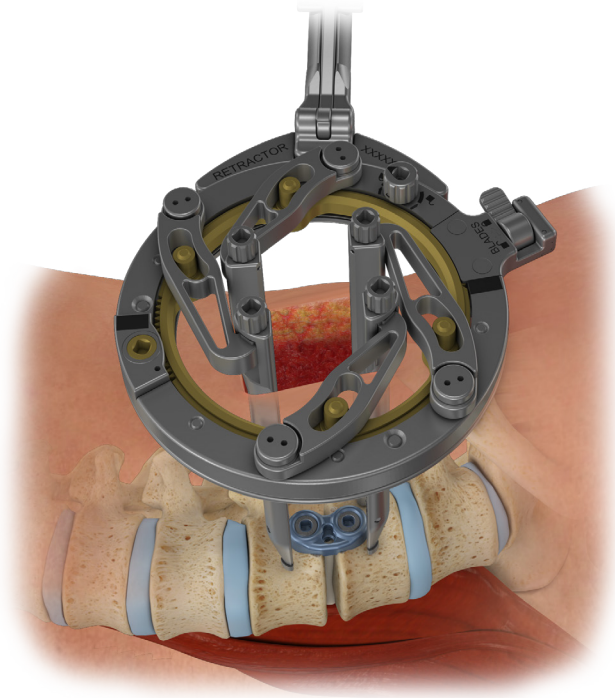

Fig. 9

9. CLOSURE

Once the procedure is completed, use final fluoroscopy imaging to confirm the placement of all implants. The Retractor can then be collapsed, detach the Light Source, and remove the Retractor from the incision under direct visualization to verify the absence of significant bleeding in the disc space or psoas (**Fig. 9**). Close the incision using standard subcuticular sutures.

10. IMPLANT REMOVAL

If removal of the Lateral Plate is required, remove the Set Screws from the plate using the Final Tightening Driver and the Plate Inserter. Remove the Bone Screws from the Plate using the Driver. Carefully remove the plate.

If removal of the Interbody is required, thread the **Implant Remover (27-5015)** completely into the proximal side of the Interbody and remove from the disc space using the **Slap Hammer (27-5016)** if necessary. The Implant Remover is secured to the Slap Hammer by inserting its connection feature into the proximal end of the Slap Hammer and turning the Slap Hammer's sleeve counter-clockwise to lock it in place.

Instruments

Part #	Description	Qty Set
Retractor Case		
71-0110	Retractor Case	1
71-1000	Retractor	1
71-1100	Blade, 100mm	5
71-1110	Blade, 110mm	5
71-1120	Blade, 120mm	5
71-1130	Blade, 130mm	5
71-1140	Blade, 140mm	5
71-1150	Blade, 150mm	5
71-1160	Blade, 160mm	5
71-1500	Retractor Driver	1
71-4100	Intradiscal Shim	2
71-4200	Bone Pin	2
71-4300	Shim Inserter	1

Accessory Case

71-0120	Retractor Accessory Case	1
71-2000	Table Arm	1
71-2010	Table Clamp	1
71-2030	Retractor Light Bracket	1
71-3030	Fiberoptic Light Cable	1
71-5010	Fluoroscopic Targeting Crosshair	1
71-5015	Guide-Wire	10

Interbody Instrument Case

27-0110	Interbody Instrument Case	1
27-5004	Modular T-Handle	2
27-5010	Implant Inserter	2
27-5011	Slide	By Request
27-5012	Tamp	1
27-5015	Implant Remover	1
27-5016	Slap Hammer	1
27-5108	8mm Distractor	1
27-5110	10mm Distractor	1
27-5112	12mm Distractor	1
27-5114	14mm Distractor	1
27-5608	8mm Graft Containment Clip	1
27-5610	10mm Graft Containment Clip	1
27-5612	12mm Graft Containment Clip	1
27-5614	14mm Graft Containment Clip	1

Sterile Packaged

71-3040	Fiberoptic Light Source	By Request
7332-99	Neuromonitoring Pack	By Request

Lateral Plate Case

24-0110	Lateral Plate Case	1
24-1001	Modular In-Line Handle	2
24-1050	Rongeur, Bone Biting	1
24-1060	Sleeved Awl	1
24-1061	Awl Sleeve	1
24-1062	Awl	1
24-1065	5.5mm Drill	2
24-1070	Plate Inserter	2
24-1092	Final Tightening Driver	2
24-1094	Driver	2
24-1095	T-Handle, Torque Limiting Driver	1

Instruments

Part #	Description	Qty Set
General Discectomy Case #1		
26-0110	General Discectomy Case #1	1
26-1004	Pituitary Rongeur, 4mm	1
26-1005	Pituitary Rongeur, 6mm	1
26-1006	Angled Kerrison Rongeur, 4mm	1
26-1007	Angled Kerrison Rongeur, 6mm	1
26-1025	Nerve Root Retractor	1
26-1108	8mm Loose Disc Cutter	1
26-1110	10mm Loose Disc Cutter	1
26-1112	12mm Loose Disc Cutter	1
26-1114	14mm Loose Disc Cutter	1
26-1208	8mm Rotating Cutter	1
26-1210	10mm Rotating Cutter	1
26-1212	12mm Rotating Cutter	1
26-1214	14mm Rotating Cutter	1
26-1306	6mm Box Chisel	By Request
26-1308	8mm Box Chisel	By Request
26-1310	10mm Box Chisel	By Request
26-1312	12mm Box Chisel	By Request
26-1314	14mm Box Chisel	By Request
26-1040	Long Penfield #5	1
26-1026	Extra-Long Suction, 10FR	1
26-1028	Extra-Long Suction, 12FR	1
26-1035	Extra-Long Insulated Bi-Polar	1

General Discectomy Case #2

26-0120	General Discectomy Case #2	1
26-1008	Curette - Up #0	1
26-1009	Curette - Up #1	1
26-1010	Curette - Up #2	1
26-1011	Curette - Straight #0	1
26-1012	Curette - Straight #1	1
26-1013	Curette - Straight #2	1
26-1014	Ring Curette, Straight	1
26-1015	Ring Curette, Angled	1
26-1018	Straight Rasp	1
26-1019	Anatomic Rasp	1
26-1020	16mm Cobb Elevator	1
26-1021	20mm Cobb Elevator	1
26-1030	Annulotomy Blade Holder	1

Interbody 18W Implant Case

27-0118	Interbody 18W Implant Case	1
27-5208	18W x 60L x 0° x 8H Trial	1
27-5210	18W x 60L x 0° x 10H Trial	1
27-5212	18W x 60L x 0° x 12H Trial	1
27-5214	18W x 60L x 0° x 14H Trial	1
27-5408	18W x 60L x 8° x 8H Trial	1
27-5410	18W x 60L x 8° x 10H Trial	1
27-5412	18W x 60L x 8° x 12H Trial	1
27-5414	18W x 60L x 8° x 14H Trial	1

Instruments

Part #	Description	Qty	Set
Interbody 22W Implant Case			
27-0122	Interbody 22W Implant Case	1	
27-5308	22W x 60L x 0° x 8H Trial	1	
27-5310	22W x 60L x 0° x 10H Trial	1	
27-5312	22W x 60L x 0° x 12H Trial	1	
27-5314	22W x 60L x 0° x 14H Trial	1	
27-5508	22W x 60L x 8° x 8H Trial	1	
27-5510	22W x 60L x 8° x 10H Trial	1	
27-5512	22W x 60L x 8° x 12H Trial	1	
27-5514	22W x 60L x 8° x 14H Trial	1	

Implants

Part #	Description	Qty	Set
Lateral Plate Case			
24-2001	Set Screw	8	
24-2006	6mm Plate	4	
24-2008	8mm Plate	4	
24-2010	10mm Plate	4	
24-2012	12mm Plate	2	
24-2014	14mm Plate	2	
24-5530	5.5mm x 30mm Bone Screw	4	
24-5535	5.5mm x 35mm Bone Screw	6	
24-5540	5.5mm x 40mm Bone Screw	6	
24-5545	5.5mm x 45mm Bone Screw	6	
24-5550	5.5mm x 50mm Bone Screw	6	
24-5555	5.5mm x 55mm Bone Screw	6	
24-5560	5.5mm x 60mm Bone Screw	4	
24-5630	6.5mm x 30mm Bone Screw	4	
24-5635	6.5mm x 35mm Bone Screw	6	
24-5640	6.5mm x 40mm Bone Screw	6	
24-5645	6.5mm x 45mm Bone Screw	6	
24-5650	6.5mm x 50mm Bone Screw	6	
24-5655	6.5mm x 55mm Bone Screw	6	
24-5660	6.5mm x 60mm Bone Screw	4	

Interbody 18W Implant Case

27-2208	18W x 40L x 0 Deg x 8H Interbody	2	
27-2210	18W x 40L x 0 DEG x 10H Interbody	2	
27-2212	18W x 40L x 0 DEG x 12H Interbody	2	
27-2214	18W x 40L x 0 DEG x 14H Interbody	2	
27-2238	18W x 40L x 8 DEG x 8H Interbody	2	
27-2240	18W x 40L x 8 DEG x 10H Interbody	2	
27-2242	18W x 40L x 8 DEG x 12H Interbody	2	
27-2244	18W x 40L x 8 DEG x 14H Interbody	2	
27-2308	18W x 45L x 0 DEG x 8H Interbody	2	
27-2310	18W x 45L x 0 DEG x 10H Interbody	2	
27-2312	18W x 45L x 0 DEG x 12H Interbody	2	
27-2314	18W x 45L x 0 DEG x 14H Interbody	2	
27-2338	18W x 45L x 8 DEG x 8H Interbody	2	
27-2340	18W x 45L x 8 DEG x 10H Interbody	2	
27-2342	18W x 45L x 8 DEG x 12H Interbody	2	
27-2344	18W x 45L x 8 DEG x 14H Interbody	2	
27-2408	18W x 50L x 0 DEG x 8H Interbody	2	
27-2410	18W x 50L x 0 DEG x 10H Interbody	2	
27-2412	18W x 50L x 0 DEG x 12H Interbody	2	
27-2414	18W x 50L x 0 DEG x 14H Interbody	2	

Implants

Part #	Description	Qty	Set
27-2438	18W x 50L x 8 DEG x 8H Interbody	2	
27-2440	18W x 50L x 8 DEG x 10H Interbody	2	
27-2442	18W x 50L x 8 DEG x 12H Interbody	2	
27-2444	18W x 50L x 8 DEG x 14H Interbody	2	
27-2508	18W x 55L x 0 DEG x 8H Interbody	2	
27-2510	18W x 55L x 0 DEG x 10H Interbody	2	
27-2512	18W x 55L x 0 DEG x 12H Interbody	2	
27-2514	18W x 55L x 0 DEG x 14H Interbody	2	
27-2538	18W x 55L x 8 DEG x 8H Interbody	2	
27-2540	18W x 55L x 8 DEG x 10H Interbody	2	
27-2542	18W x 55L x 8 DEG x 12H Interbody	2	
27-2544	18W x 55L x 8 DEG x 14H Interbody	2	

Interbody 22W Implant Case

27-3208	22W x 40L x 0 DEG x 8H Interbody	2	
27-3210	22W x 40L x 0 DEG x 10H Interbody	2	
27-3212	22W x 40L x 0 DEG x 12H Interbody	2	
27-3214	22W x 40L x 0 DEG x 14H Interbody	2	
27-3238	22W x 40L x 8 DEG x 8H Interbody	2	
27-3240	22W x 40L x 8 DEG x 10H Interbody	2	
27-3242	22W x 40L x 8 DEG x 12H Interbody	2	
27-3244	22W x 40L x 8 DEG x 14H Interbody	2	
27-3308	22W x 45L x 0 DEG x 8H Interbody	2	
27-3310	22W x 45L x 0 DEG x 10H Interbody	2	
27-3312	22W x 45L x 0 DEG x 12H Interbody	2	
27-3314	22W x 45L x 0 DEG x 14H Interbody	2	
27-3338	22W x 45L x 8 DEG x 8H Interbody	2	
27-3340	22W x 45L x 8 DEG x 10H Interbody	2	
27-3342	22W x 45L x 8 DEG x 12H Interbody	2	
27-3344	22W x 45L x 8 DEG x 14H Interbody	2	
27-3408	22W x 50L x 0 DEG x 8H Interbody	2	
27-3410	22W x 50L x 0 DEG x 10H Interbody	2	
27-3412	22W x 50L x 0 DEG x 12H Interbody	2	
27-3414	22W x 50L x 0 DEG x 14H Interbody	2	
27-3438	22W x 50L x 8 DEG x 8H Interbody	2	
27-3440	22W x 50L x 8 DEG x 10H Interbody	2	
27-3442	22W x 50L x 8 DEG x 12H Interbody	2	
27-3444	22W x 50L x 8 DEG x 14H Interbody	2	
27-3508	22W x 55L x 0 DEG x 8H Interbody	2	
27-3510	22W x 55L x 0 DEG x 10H Interbody	2	
27-3512	22W x 55L x 0 DEG x 12H Interbody	2	
27-3514	22W x 55L x 0 DEG x 14H Interbody	2	
27-3538	22W x 55L x 8 DEG x 8H Interbody	2	
27-3540	22W x 55L x 8 DEG x 10H Interbody	2	
27-3542	22W x 55L x 8 DEG x 12H Interbody	2	
27-3544	22W x 55L x 8 DEG x 14H Interbody	2	

Please visit [Orthofix.com/IFU](https://www.orthofix.com/IFU) for full information on indications for use, contraindications, warnings, precautions, adverse reactions and sterilization.

Caution: Federal law (USA) restricts this device to sale by or on the order of a physician. Proper surgical procedure is the responsibility of the medical professional. Operative techniques are furnished as an informative guideline. Each surgeon must evaluate the appropriateness of a technique based on his or her personal medical credentials and experience.



Orthofix
3451 Plano Parkway
Lewisville, Texas 75056-9453 USA
1.214.937.3199
1.888.298.5700
www.orthofix.com



Medical Device Safety Services (MDSS):
Schiffgraben 41
30175, Hannover
Germany
+49 511 6262 8630
www.mdss.com

Rx Only
CE²⁷⁹⁷

Orthofix products or services referenced herein are trademarks or registered trademarks of Orthofix Medical Inc. and its group of companies. Any rights not expressly granted herein are reserved.